









MICROWELL ARRAY CHIP AND ITS MANUFACTURING METHOD**Publication number:** WO2005069001**Publication date:** 2005-07-28**Inventor:** MURAGUCHI ATSUSHI (JP); KISHI HIROYUKI (JP); TOKIMITSU YOSHIHARU (JP); KONDO SACHIKO (JP); OBATA TSUTOMU (JP); FUJIKI SATOSHI (JP); YOKOYAMA YOSHIYUKI (JP); NABESAWA HIROFUMI (JP); TAKABAYASHI SOTOHIRO (JP); TANINO KATSUMI (JP)**Applicant:** TOYAMA PREFECTURE (JP); MURAGUCHI ATSUSHI (JP); KISHI HIROYUKI (JP); TOKIMITSU YOSHIHARU (JP); KONDO SACHIKO (JP); OBATA TSUTOMU (JP); FUJIKI SATOSHI (JP); YOKOYAMA YOSHIYUKI (JP); NABESAWA HIROFUMI (JP); TAKABAYASHI SOTOHIRO (JP); TANINO KATSUMI (JP)**Classification:****- international:** G01N33/53; G01N33/543; G01N37/00; G01N33/53; G01N33/543; G01N37/00; (IPC1-7): G01N33/53; G01N37/00**- European:** G01N33/543K**Application number:** WO2004JP14285 20040922**Priority number(s):** JP20030333363 20030925; JP20030336771 20030929; JP20030336793 20030929**Also published as:** EP1691196 (A1)
 US2008014631 (A1)
 KR20060091318 (A)
 CA2544470 (A1)**Cited documents:** WO02055653
 JP5240869
 JP63106565
 JP2003033177[Report a data error here](#)**Abstract of WO2005069001**

A microwell array chip comprising microwells in one major surface of a substrate. Each microwell has such a shape and dimensions that it contains only one living cell. On the major surface of the substrate where the openings of the microwells are provided, markers for the microwells are provided. Another microwell array chip comprising microwells in one major surface of a substrate. Each microwell has such a shape and dimensions that it contains only one living cell. A projection portion narrowing the opening of each microwell is disposed in the opening. A method for manufacturing the microwell array chip comprises a step of forming a film at least on one major surface of a substrate, a step of applying a resist to the formed film, a step of exposing the resist surface through a mask having a microwell pattern and removing the uncured portion of the resist, a step of making a hole of microwell array shape by etching the film and the exposed portion of the substrate, and a step of removing the resist. Further, another microwell array chip of a silicon having microwells in each of which one living cell of a subject is contained. Each microwell has such a shape and dimensions that it contains only one living cell.

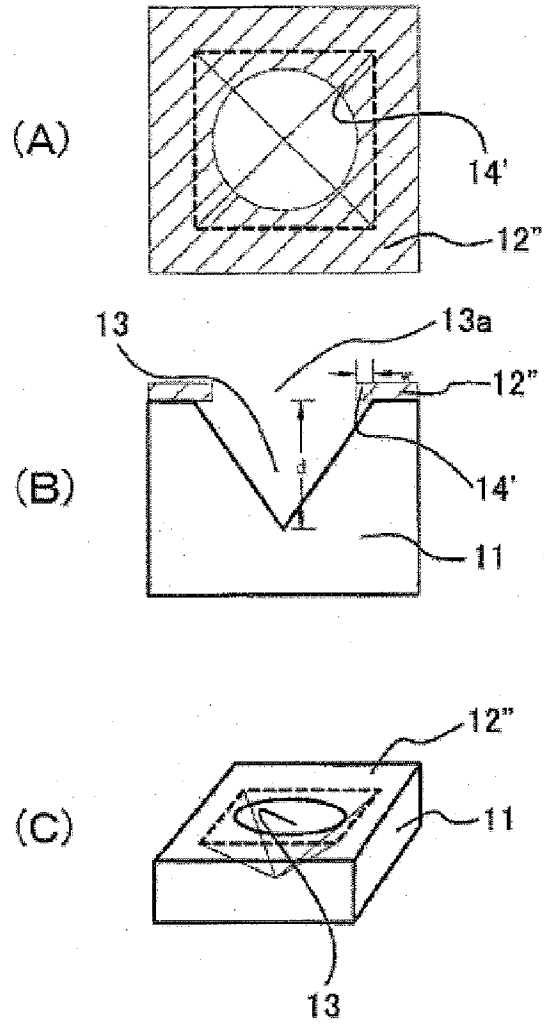

Data supplied from the *esp@cenet* database - Worldwide